



SUMMERVILLE

48 Inch Tall Oval Pools

Parts List



(Not actual pool)

SUMMERVILLE Oval Pool — Parts List

ITEM #	DESCRIPTION	20' x 12' x 48"		24' x 12' x 48"		24' x 16' x 48"		28' x 16' x 48"		32' x 16' x 48"	
		PART #	QTY.	PART #	QTY.	PART #	QTY.	PART #	QTY.	PART #	QTY.
	ASSEMBLY PACK	0-9902-614	1	0-9942-614	1	0-9946-614	1	0-9986-614	1	0-9926-614	1
1.	Plastic Coping, 24"	545-1001	30	545-1001	33	545-1001	36	545-1001	40	545-1001	44
2.	Vertical End Cap-Top	580-2286	10	580-2286	10	580-2286	12	580-2286	12	580-2286	12
3.	Vertical End Cap-Bottom	580-1949	10	580-1949	10	580-1949	12	580-1949	12	580-1949	12
4.	Stabilizer Rail, small dia.	583-1012	8	583-1012	8	583-1012	10	583-1012	10	583-1012	10
5.	Stabilizer Rail, large dia.	583-1011	10	583-1011	12	583-1011	10	583-1011	12	583-1011	14
6.	Bottom Rail (Stamped 12 or 16)	589-1046	12	589-1046	12	589-1047	10	589-1047	10	589-1047	10
7.	Side Rail (Stamped S)	589-1052	2	589-1052	4	589-1052	2	589-1052	4	589-1052	6
8.	Bottom Rail (Stamped TR)	—	—	—	—	589-1053	4	589-1053	4	589-1053	4
9.	6" Outer Connector	580-1886	14	580-1886	16	580-1886	16	580-1886	18	580-1886	20
10.	Outer Connector Bracket	580-2128	14	580-2128	16	580-2128	16	580-2128	18	580-2128	20
11.	Inner Connector	5186-1205	14	5186-1205	16	5186-1205	16	5186-1205	18	5186-1205	20
12.	Side Vertical Cap	580-2056	4	580-2056	6	580-2056	4	580-2056	6	580-2056	8
*13.	Machine Screw, 10-24 x 1/2"	510-1008	14	510-1008	16	510-1008	16	510-1008	18	510-1008	20
*14.	Square Nut, 10-24	321-1025	14	321-1025	16	321-1025	16	321-1025	18	321-1025	20
*15.	Sheet Metal Screw #10 x 1/2"	330-1127	132	330-1127	148	330-1127	152	330-1127	168	330-1127	184
16.	Pool Parts List	573-3538	1	573-3538	1	573-3538	1	573-3538	1	573-3538	1
17.	Pool Installation Instructions	573-3308	1	573-3308	1	573-3308	1	573-3308	1	573-3308	1
18.	"Read Me First" Booklet	573-3169	1	573-3169	1	573-3169	1	573-3169	1	573-3169	1
19.	—	—	—	—	—	—	—	—	—	—	—
20.	—	—	—	—	—	—	—	—	—	—	—
21.	—	—	—	—	—	—	—	—	—	—	—
22.	—	—	—	—	—	—	—	—	—	—	—
23.	Warranty Card - Metal	—	1	—	1	—	1	—	1	—	1
24.	—	565-1169	1	565-1169	1	565-1169	1	565-1169	1	565-1169	1
25.	Top Rail	—	—	—	—	587-1691	2	587-1691	4	587-1691	6
	VERTICAL PACK	0-9710-613	1	0-9710-613	1	0-9712-613	1	0-9712-613	1	0-9712-613	1
26.	Vertical	580-2185	10	580-2185	10	580-2185	12	580-2185	12	580-2185	12
	TOP RAIL PACK	0-9841-614	1	0-9861-614	1	0-9814-614	1	0-9814-614	1	0-9814-614	1
27.	Top Rail	587-1691	14	587-1691	16	587-1692	14	587-1692	14	587-1692	14
	POOL LINER CARTON	0-2012-___	1	0-2412-___	1	0-2416-___	1	0-2816-___	1	0-3216-___	1
***28.	Pool Liner	0-2012-___	1	0-2412-___	1	0-2416-___	1	0-2816-___	1	0-3216-___	1
29.	Chlorine/Winterizing Instructions	573-2421	1	573-2421	1	573-2421	1	573-2421	1	573-2421	1
30.	Installation Instruction Insert	369-1145	1	369-1145	1	369-1145	1	369-1145	1	369-1145	1
31.	"Warning" Decal	560-1041	3	560-1041	3	560-1041	3	560-1041	1	560-1041	1
32.	Warranty Card - Liner	—	1	—	1	—	1	—	1	—	1
**33.	Repair Patch	564-1000	1	564-1000	1	564-1000	1	564-1000	1	564-1000	1
***34.	"Deeper" Area Decal	560-1042	2	560-1042	2	560-1042	2	560-1042	2	560-1042	2
35.	"Shallow" Decal, 3-1/2 ft.	560-1043	3	560-1043	3	560-1043	3	560-1043	3	560-1043	3
36.	"Read Me First" Booklet	573-3169	1	573-3169	1	573-3169	1	573-3169	1	573-3169	1
	SIDEWALL CARTON	0-0011-002	1	0-0011-042	1	0-0011-046	1	0-0011-086	1	0-0011-026	2
37.	Sidewall	0-0011-002	1	0-0011-042	1	0-0011-046	1	0-0011-086	1	0-0011-026	2
38.	Cover Plate - Large (not shown)	—	—	—	—	—	—	—	—	580-2340	2
39.	Cover Plate - Small (not shown)	—	—	—	—	—	—	—	—	580-2341	2
40.	Joint Piece	580-1002	1	580-1002	1	580-1002	1	580-1002	1	580-1002	2
41.	"Warning" Sign	560-1046	1	560-1046	1	560-1046	1	560-1046	1	560-1046	2
42.	"Read Me First" Booklet	573-3169	1	573-3169	1	573-3169	1	573-3169	1	573-3169	2
43.	Adhesive Squares	310-1034	6	310-1034	6	310-1034	6	310-1034	6	310-1034	12
44.	Safety Video	573-3498	1	573-3498	1	573-3498	1	573-3498	1	573-3498	2
	SUPPORT BASE PACK 4 — CARTON	0-8888-204	1	—	—	0-8888-204	1	—	—	0-8888-204	2
	SUPPORT BASE PACK 6 — CARTON	—	—	0-8888-206	1	—	—	0-8888-206	1	—	—
45.	Skid Support	580-1779	4	580-1779	6	580-1779	4	580-1779	6	580-1779	8
46.	Ground Support - Top	580-2071	4	580-2071	6	580-2071	4	580-2071	6	580-2071	8
47.	Ground Support - Bottom	580-2072	4	580-2072	6	580-2072	4	580-2072	6	580-2072	8
48.	Pressure Pad - Inside	580-1870	4	580-1870	6	580-1870	4	580-1870	6	580-1870	8
49.	Pressure Pad - Outside	580-1869	4	580-1869	6	580-1869	4	580-1869	6	580-1869	8
50.	Bottom Rail Locator	580-1792	4	580-1792	6	580-1792	4	580-1792	6	580-1792	8
*51.	Hex Washer Head Screw #12 x 3/4"	510-1035	24	510-1035	36	510-1035	24	510-1035	36	510-1035	48
*52.	Hex Head Bolt, 3/8-16 x 3-1/2"	330-1220	16	330-1220	24	330-1220	16	330-1220	24	330-1220	32
*53.	Hex Nut, 3/8-16	321-1069	16	321-1069	24	321-1069	16	321-1069	24	321-1069	32
*54.	Hex Head Screw, 1/4"-20 x 1/2"	510-1018	16	510-1018	24	510-1018	16	510-1018	24	510-1018	32
510-1018		32									
*55.	Hex Nut, 1/4-20	511-1000	16	511-1000	24	511-1000	16	511-1000	24	511-1000	32
*56.	Sheet Metal Screw, #10 x 1/2"	330-1127	24	330-1127	36	330-1127	24	330-1127	36	330-1127	48
	SUPPORT PACK 4 CARTON	0-8848-400	1	—	—	0-8848-400	1	—	—	0-8848-400	2
	SUPPORT PACK 6 CARTON	—	—	0-8848-600	1	—	—	0-8848-600	1	—	—
57.	Side Vertical	580-2138	4	580-2138	6	580-2138	4	580-2138	6	580-2138	8

8

*Screws are available in most hardware stores.

**For additional patch kits order Part No. 0-5604-000.

***Write the number of your liner in the spaces provided here and above. # _____.

EXPLODED VIEW

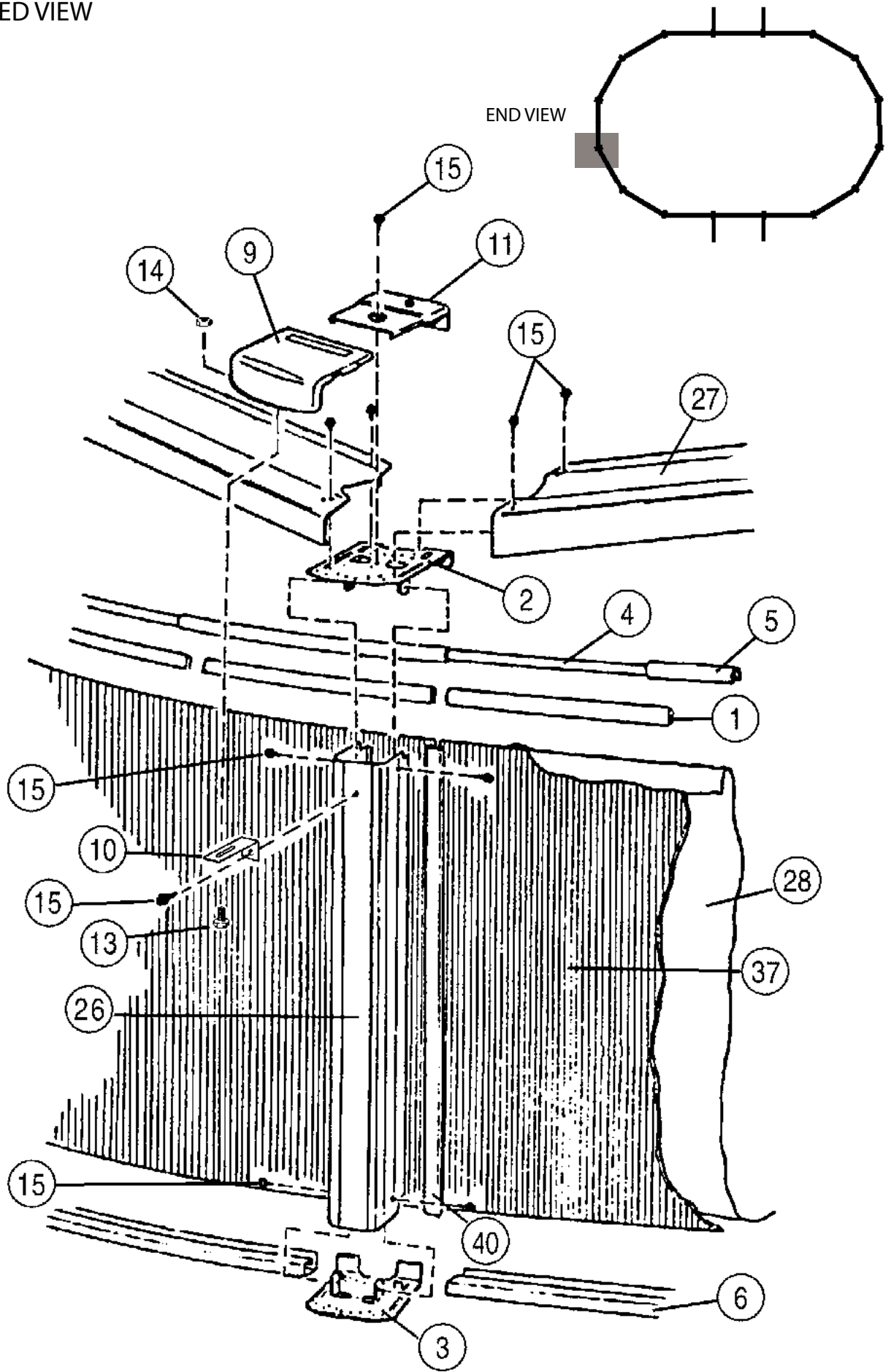

EXPLODED VIEW

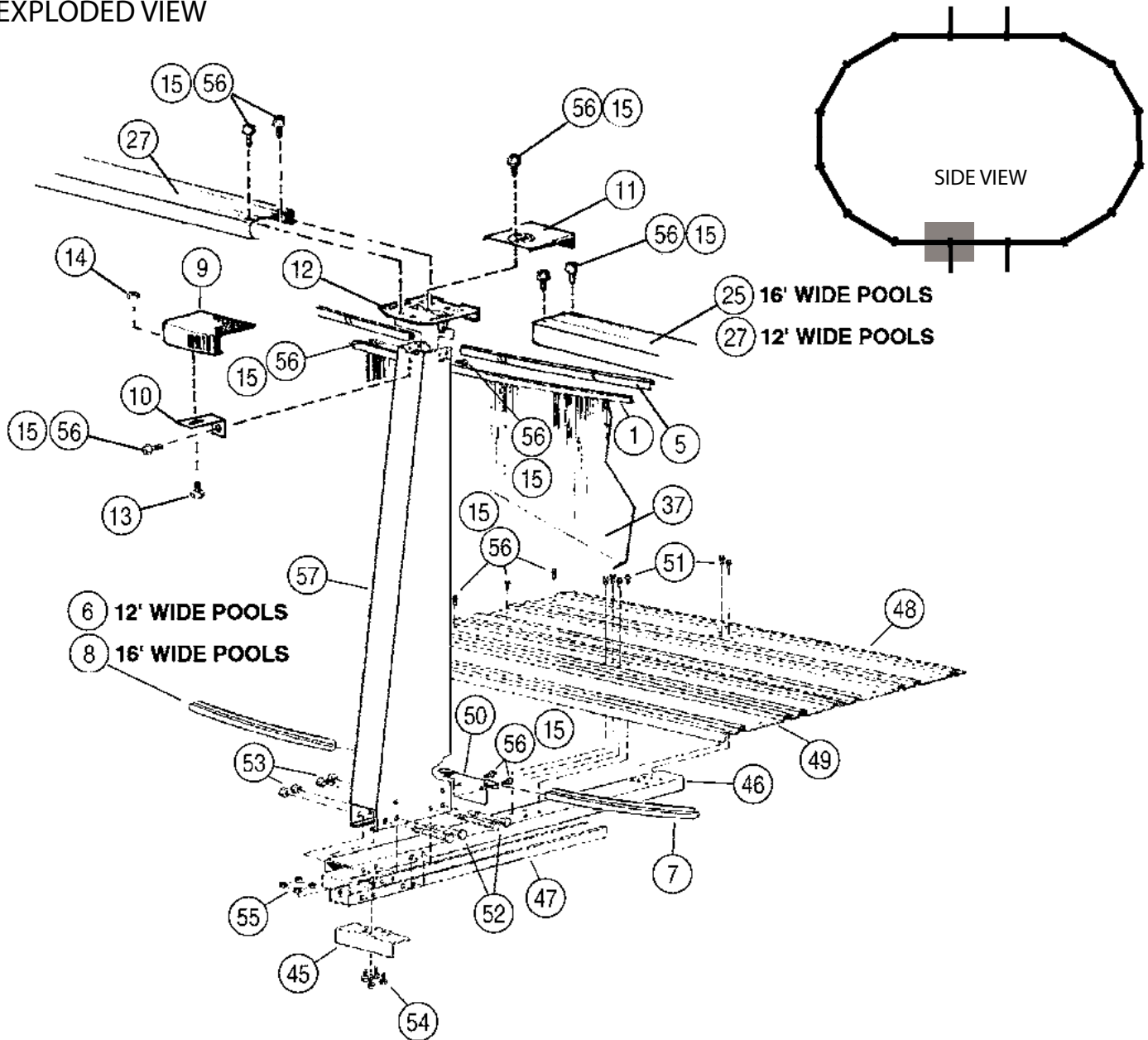

Important! Above-ground pools are designed for swimming and wading only. Do not Dive or Jump! Misuse of your pool may result in crippling injury and/or other dangers to life and health. Do not use slides, diving boards, or any other platform or object which can be used for improper pool entry. Use only an above-ground swimming pool ladder or entry system to enter or exit your pool. Never attempt to swim or reach behind ladders or any other pool entry system. It is the pool owner's responsibility to secure the pool against unauthorized, unsupervised or unintentional entry. It is also the pool owner's responsibility to warn all pool users of the hazards of diving into shallow water: paralyzing injury may result. Always obey all safety rules. Remember, pool safety is everybody's responsibility.

Safety decals and caution information provided with your pool have been endorsed by the U.S. Consumer Product Safety Commission. It is mandatory that the pool owner and installer follow the installation and use directions for all provided safety signs and decals. Juveniles must be supervised at all times by a responsible adult as directed by the USCPSC.

Change of Design: Doughboy Recreational expressly reserves the right to change or modify the design and construction of any product in due course of their manufacturing procedures, without incurring any obligation to furnish or install such changes or modifications on products previously or subsequently sold.



DOUGHBOY RECREATIONAL • 315 N. Sebastian St. • West Helena, AR 72390
 Visit our website at www.doughboy-pools.com